



## Digital Twins: Essential to Driving Sustainable Operations for Chemical Producers

by Paige Marie Morse, PhD, Sustainability Advisor, Aspen Technology, Inc.  
by Geeta Pherwani, Sr. Product Marketing Manager, Aspen Technology, Inc.



## Introduction

Asset intensive industries are facing a challenging future. They must manage the fragile balance of adopting sustainable operations while meeting shareholder expectations for profitability. At the same time, volatile and uncertain market conditions and a rapidly changing workforce are contributing to a loss of domain knowledge and expertise, and creating complicated operating scenarios that demand new solutions.

For chemical producers, digital technologies continue to be an essential enabler for kickstarting sustainability initiatives and reaching targets. For example, digital solutions can help organizations more easily integrate data from isolated systems to a centralized location, providing insights to drive improved business decisions for sustainable operations.

Additionally, digitalization further enables organizations to assess and analyze multiple simulations in parallel by creating variations of original simulation models, known as digital twins. These detailed simulations provide new levels of operational excellence through enterprise-wide insights that drive improved business and sustainability operations. Artificial intelligence (AI) can provide additional sophistication to the digital twins by increasing the level of prediction accuracy in the models that enhance safety, reliability and intuitiveness of the processes.

# Sustainability Initiatives Challenge Current Business Models

Three main levers drive sustainability initiatives for asset-intensive companies: Resource efficiency, circular economy and energy transition.

For many companies, the immediate focus is Resource Efficiency: the efficient use of energy, water and feedstock in current operations. Longer term, many companies are challenged by the unique demands of the circular economy, where economic activity is decoupled from the consumption of finite resources and waste is re-integrated into processes.

In addition, the high energy intensity of many chemical processes is forcing many chemical companies to engage directly in the energy transition, sometimes in partnership with energy companies.

Overall this shift is forcing a fundamental rethinking of current business models as well as the tools and capabilities required to meet new objectives for success. The sheer volume of information to be analyzed and need for agility and scenario development create a unique challenge.



## Sustainability Is Driving Significant Initiatives Across Industry Segments

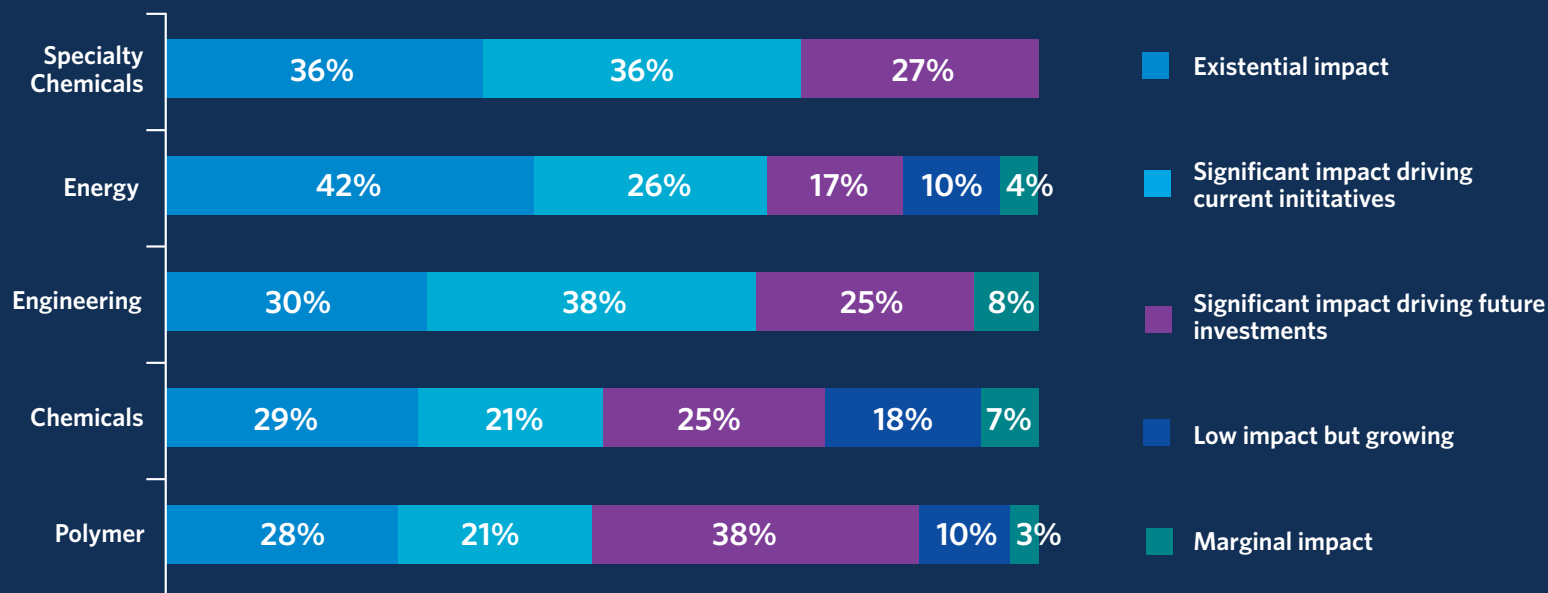

Figure 1: Impact of sustainability on key business initiatives across industries, from the AspenTech Sustainability Global Survey, June 2021.

# Kickstart Sustainability Journey Using Digital Twins

Digital twins provide valuable models that either connect to plant data for continuous monitoring or run offline to safely explore what if analyses without risking the plant performance. These simulations of actual operations can provide companies with comprehensive solution that can optimize asset performance across multiple dimensions of sustainability, safety and profitability through adaptive models, shared data and advanced visualization.

There are a number of digital twin solutions available on the market, and it can be difficult to know where to begin when choosing the one that's right for your needs. Here are three "needs" you might want to consider for your business before making any decisions:

- Do you need to plan and optimize operations throughout the value chain to build a robust sustainability program?
- Is there a need for online/offline monitoring across an entire asset for meeting sustainability targets or testing new solutions?
- Do you have the insights for enhanced collaboration to make informed decisions at every business level?

The industry-leading digital twin from AspenTech is one such solution that can help you meet these needs. With 40 years of process industry experience, AspenTech is uniquely positioned to provide the entire solution building from chemicals simulation expertise to vertically integrated production and the end-to-end value chain.

## AspenTech Digital Twins Accelerate the Sustainability Journey

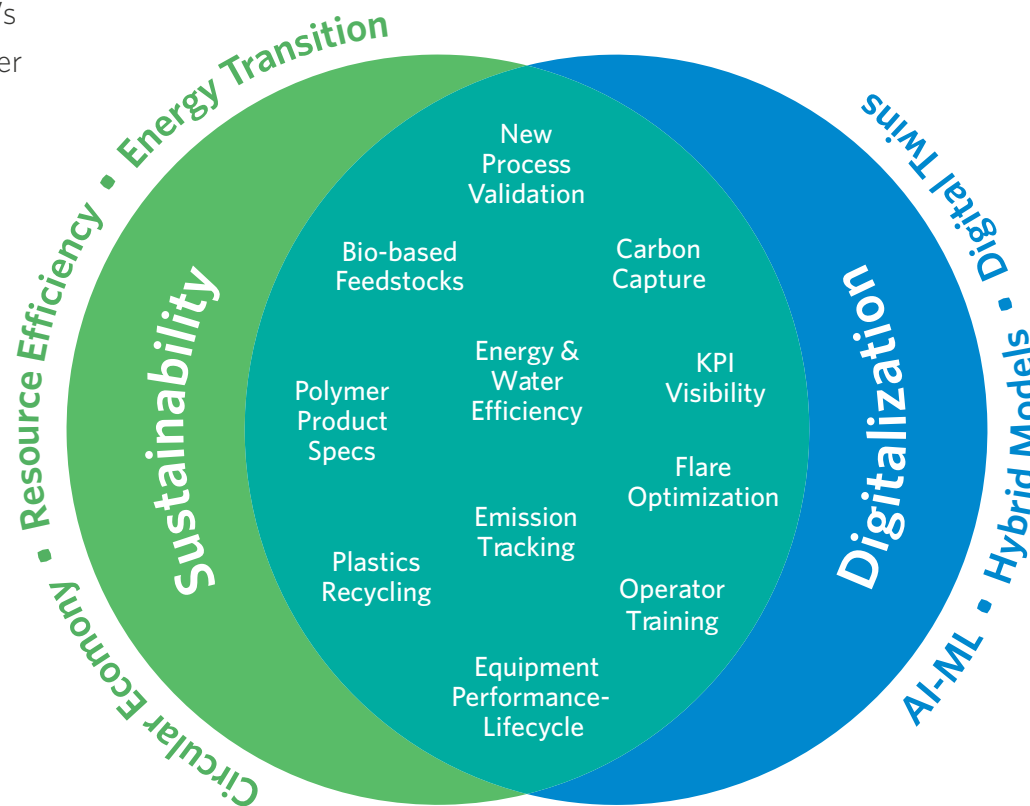

Figure 2. AspenTech's digital twin solutions to meet sustainability objectives.



**SABIC**, a global chemical manufacturer, in conjunction with its partner company Kemya (50-50 joint venture between SABIC and ExxonMobil affiliate Exxcon Chemical Arabia) used AspenTech's digital twin solution to plan its energy management system.

In 2009, SABIC launched a sustainability program to reduce greenhouse gas emissions, and energy and water consumption, by 25 percent and reduce the material loss by 50 percent by 2025. Over the last five years, strategic initiatives have helped SABIC improve emissions and plant efficiencies, leading to 10-15 percent improvement towards reaching the sustainability initiatives.

SABIC developed utilities digital twin models for energy management using the Aspen Utilities Planner™ solution to accelerate its sustainability journey. The solution has helped SABIC identify energy losses at the equipment level and perform an overall utility system optimization to maximize energy gain. The utilities digital twin helped SABIC obtain a comprehensive view of the utility system and identify site opportunities for efficient equipment selection and optimization of the overall steam system. Since then, SABIC has created utility models for 10 plants, obtaining numerous benefits to maximize energy gains and reduce GHG emissions.

“Aspen Utilities Planner brings a wide range of visibility into utilities operationsto enable new levels of sophistication, energy opportunity identification and improvement.”

— Azzam Adel Homeida, Energy and Sustainability Engineer, Kemya



# SABIC's Optimized Utility System

## Illustration Scenario:

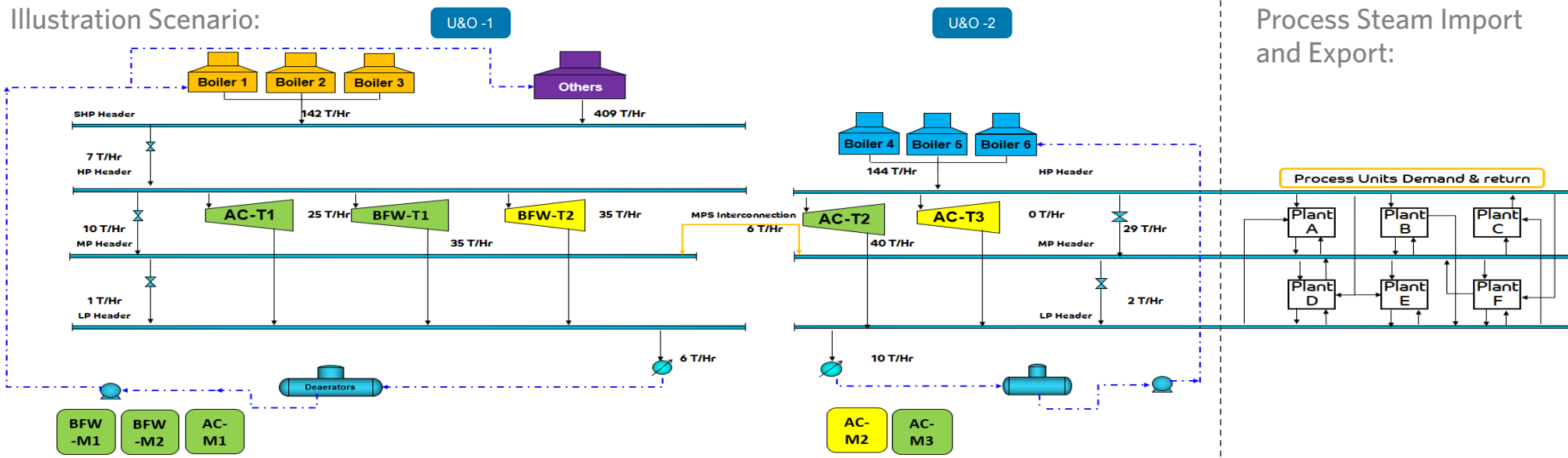

Figure 3. Illustration of Sabic's Optimized Utility System.

Digitalization continues to play a vital role in SABIC's ability to accelerate its sustainability journey. Specifically, the Aspen Utilities Planner solution helped SABIC gain visibility on consumption patterns, enabling them to regulate energy and utility losses at the equipment level. During a 30-day period, SABIC gained nearly 130 GJ/h for a single site, equivalent to nearly 60,000 tons CO<sub>2</sub> reduction per year (assumes natural gas usage).<sup>1</sup>

## Actual and Forecasted Energy Gain

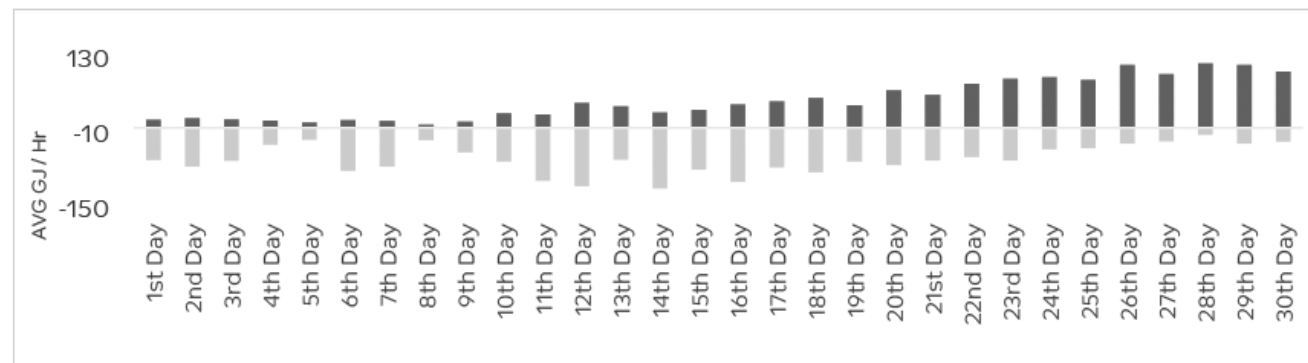

Figure 4. Sabic's actual and forecasted energy gains with Aspen Utilities Planner for a 30-day period.

# Digital Twins Enable Key Insights for Sustainable Operations

Digital twin models can be used as an alternative to sensor and testing approach to track emissions of CO<sub>2</sub> and other pollutants. The combination of process data and simulation tools such as Aspen HYSYS® and Aspen Plus® provide the means to convert the information captured in the process databases into true process knowledge. This enables companies to mitigate the faulty analyzers and accurately estimate the emissions of the whole plant, including the non-measurable emission points ensuring plant-wide emissions compliance to increasing regulations.

**Bharat Petroleum Corporation Limited (BPCL)**, an Indian refining and petrochemical company, developed its 'Digital Twin Refinery Emission Model' for its Kochi Refinery. It improves monitoring transparency and maintains compliance under dynamic emissions rules, and helps the operations team choose an optimum fuel mix to reduce emissions while balancing profitability. The team created steady state emissions prediction models using Aspen HYSYS. The models were validated and connected to the data historian for online real-time data collection, and then used to create customized visualization dashboards to monitor CO<sub>2</sub>, NO<sub>x</sub>,

CO, SO<sub>2</sub> and other pollutant emissions generated from a number of refinery sources.<sup>2</sup>

BPCL's model received an ASSOCHAM Innovators Excellence Award in 2020. In [acknowledging the award](#), Murali Madhavan, Executive Director of the Kochi Refinery, specifically thanked AspenTech for guiding the company during the online implementation of the model.



## System Architecture for Emissions Monitoring Digital Twin

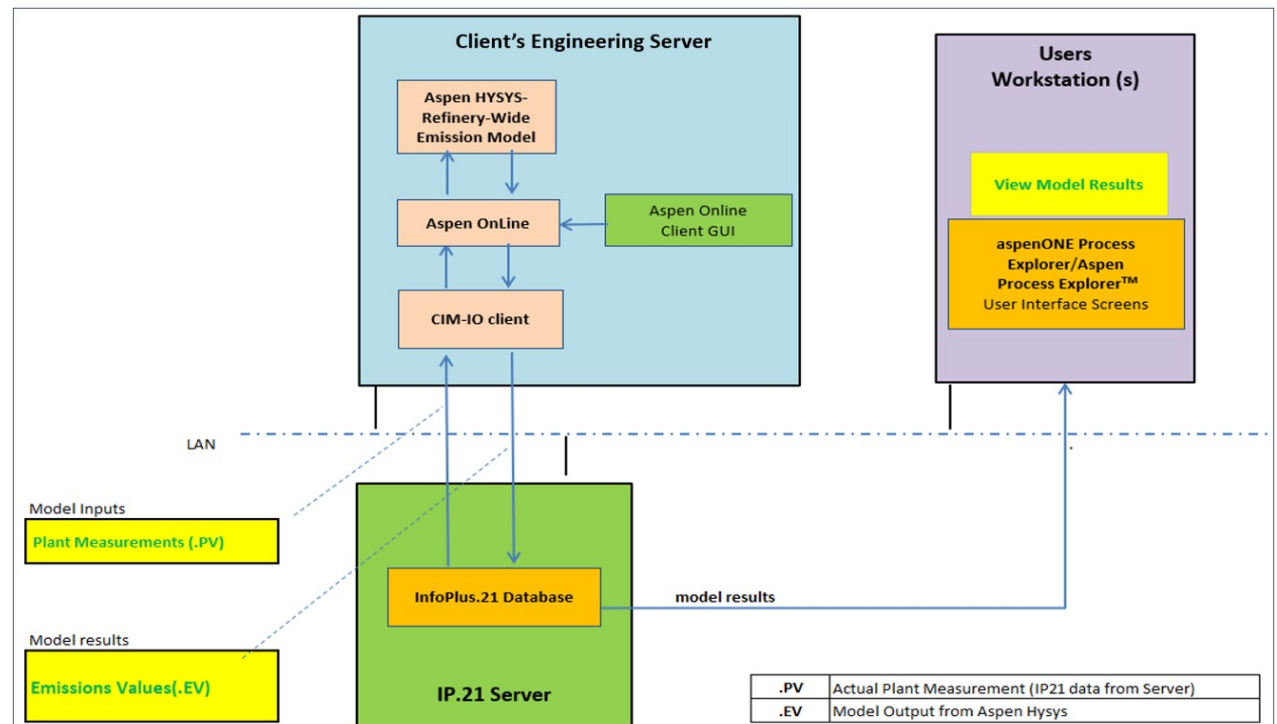

Figure 5. System architecture for BPCL's emissions monitoring digital twin.



Digital dashboards provided enhanced visibility of sustainability metrics for easy charting, thus highlighting progress on sustainability. This reporting increased employee awareness of sustainability practices and enabled better transparency to outside stakeholders.



## Emissions Quick Access Digital Dashboard for BPCL Site

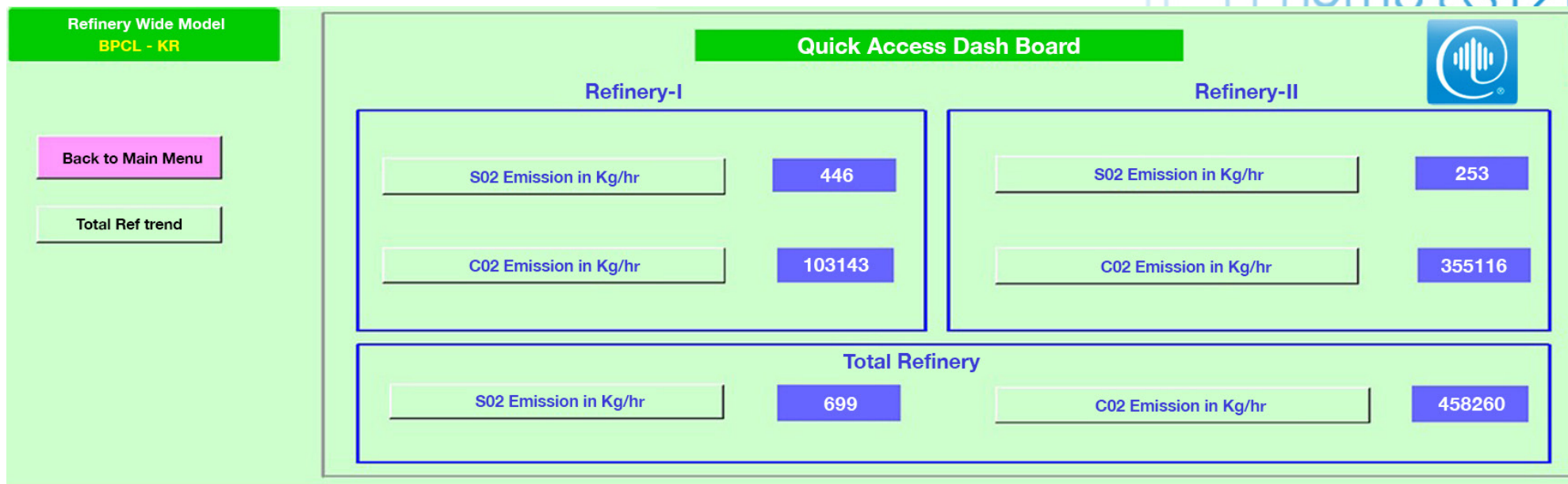

Figure 6. BPCL's emissions quick access digital dashboard.

## Digital Twins Accelerate Sustainability Efforts with Integrated Operations

Supply chain efficiencies gained through digitalization were highlighted as a key tool to improve sustainability progress in a recent report published by the European Petrochemical Association. The report, 'Digitalisation as an Enabler for a Sustainable Future', states that

"Digital technologies improve supply chain visibility, which offers the opportunity to improve scheduling, to eliminate activities that are not adding value, and to optimize the use of the assets and the resources."<sup>3</sup>



**FP Corporation** (FPCO), Japan's largest manufacturer of food containers, works to provide a stable and responsive food distribution in an efficient and environmentally-friendly way. Its complex production and distribution network with 10,000 products demanded a detailed solution to optimize transportation and inventory costs while also integrating post-consumer plastic back into its operations.

Working with AspenTech partner Time Commerce, FPCO used **aspenONE® Supply Chain Management (SCM)** to reduce CO<sub>2</sub> emissions by 160,000 MTs and waste by 443,000 MTs for fiscal year 2019. AspenTech and FPCO won the 2020 Supply and Demand Chain Executives Green Supply Chain Award for this effort in creating a sustainable, recycling-oriented society.<sup>1</sup>

## Digital Twins Enable the Circular Economy

The circular economy approach not only decreases waste production but also enables organizations to evaluate new sustainable operations without the additional cost of raw materials. One of the biggest challenges with this approach currently is ensuring collaborative decision-making between

different units and disciplines that results in a truly circular solution. Digital twins provide insights into these processes allowing organizations to work collaboratively and holistically to compare existing operations with future alternatives.

**BASF** Group successfully reduced CO<sub>2</sub> emissions from 40 metric tons in 1990 to 22 metric tons in 2018, while simultaneously doubling its sales volume. The company has further targeted carbon neutral growth by 2030 with its carbon management system—including process optimization, energy management, technology research for clean fuel and purchase of renewable energy—to reduce the company's overall carbon footprint.



For one of the initiatives in its sustainability program, BASF redesigned its methanol production process to cut CO<sub>2</sub> emissions by recycling the carbon containing off-gases back into the process. Engineers used an offline digital twin to evaluate the new application for the redesign. The complex digital twin was developed using Aspen Plus to streamline the steps of the process and at the same time obtain a holistic view of the whole process. The model helped them save energy by avoiding usage of fired heater, typical for methanol synthesis.

Keys steps included methanol synthesis and distillation, OxyFuel boiler, and BASF's patented process for carbon capture and storage, OASE<sup>®</sup> blue. Reinvention of processes and integration of raw materials, products across these processes enabled significant productivity gains and emissions reductions.<sup>1</sup>

## Absolute Greenhouse Gas (GHG) Emissions

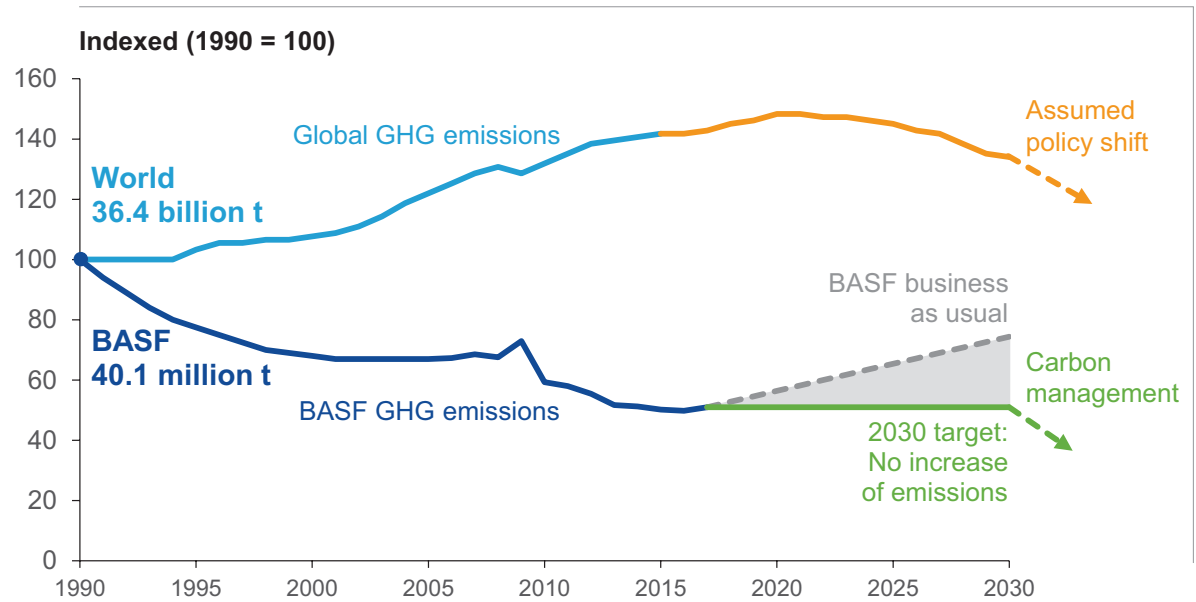

Figure 7. BASF's greenhouse gas emissions 1990 to 2030 (projected).

## BASF's CO<sub>2</sub> Emission Free Methanol Production Process

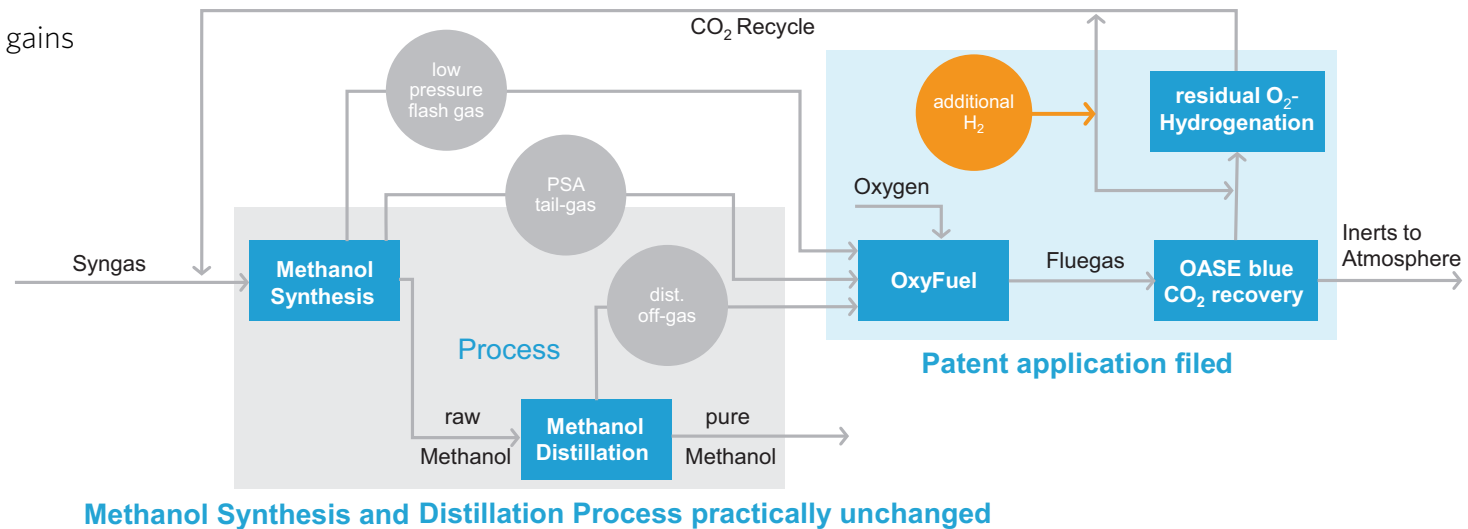

Figure 8. BASF's CO<sub>2</sub> emission free methanol production process.



Digital twins can also be used for unit optimization and operational improvements. **Hanwha Solutions Corporation** has a corporate initiative to build a smart factory to become more competitive by maximizing profits and minimizing risks while achieving its carbon neutrality objectives. This multinational energy services, petrochemical, and real estate development company headquartered in Seoul, South Korea, was working towards implementing a solution in its processes that can help operations, safety, environment, and training to help prepare operators to handle actual scenarios and potentially dangerous situations without directly experiencing them.

Hanwha identified the benefit of a digital twin solution to help with its challenges. The digital twin of the hydrocarbon resin manufacture process was modeled with Aspen Plus and Aspen Plus Dynamics. The models were used to simulate both steady state and dynamic conditions to improve operations through modeling transitions, catalyst deactivation and product quality improvement strategies.

Hanwha applied the Aspen Plus-based digital twin model to various applications, including one to optimize solvent recovery tower in the polymerization section and run feasibility studies of solvent selection for the hydrogenation section of the process. The use of digital twin model offered insights into solvent management and enabled the reduction of solvent waste by 29 percent in four months and the new solvent offered savings of \$0.5 million per year for the hydrocarbon resin manufacture process.<sup>1</sup>





## Hanwha's Target Process for Digital Twins

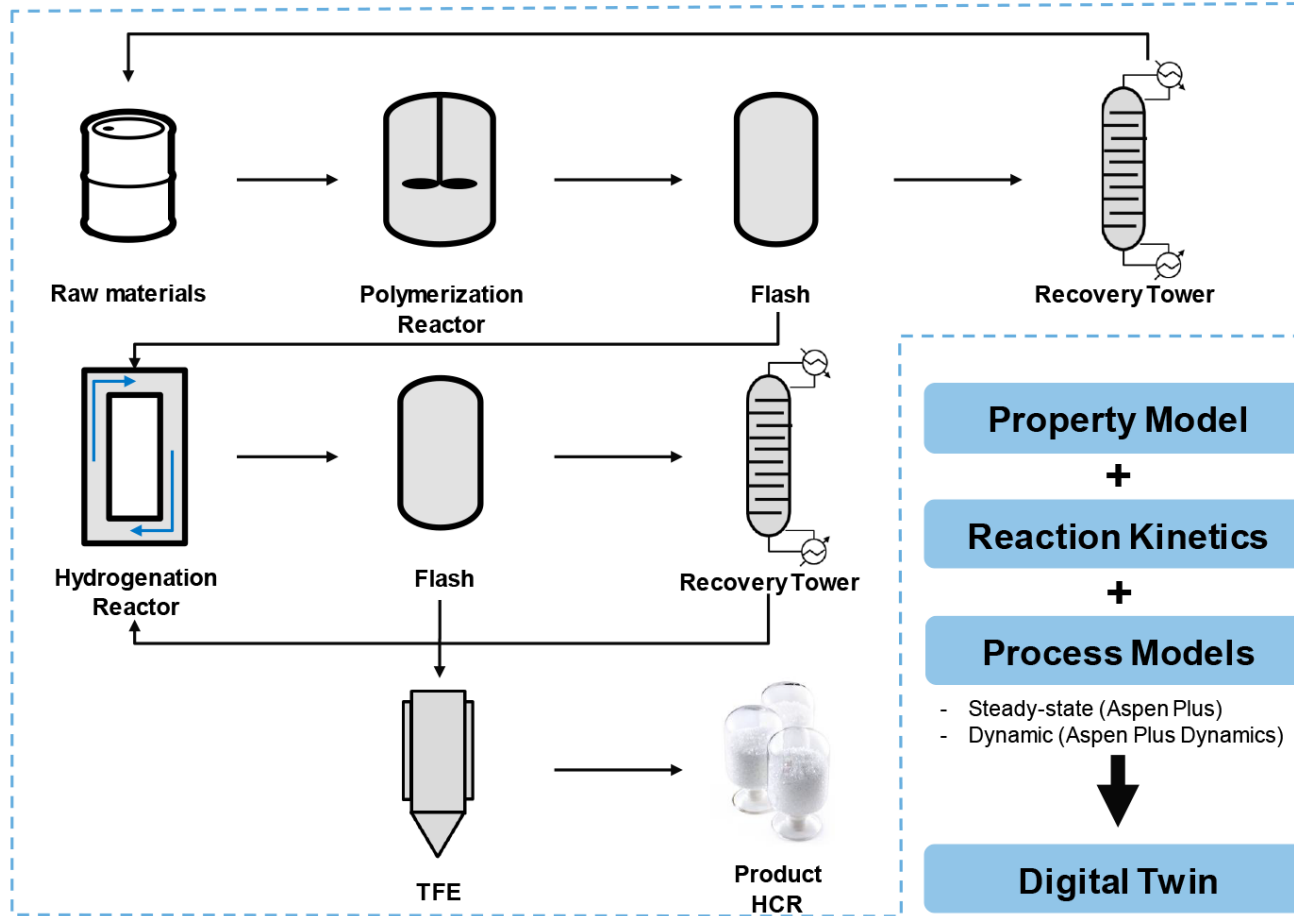

Figure 9. Hanwha's target process for digital twins.

Hanwha plans to further improve the models by applying AI, specifically machine learning, to key product quality indicators. Machine learning leverages simulation or plant data,

integrating domain knowledge and engineering constraints to build an enriched model without requiring the user to have deep process or AI expertise.







**Nissan Chemical Corporation** needed to reduce costs in its ammonia process. Beginning with the steam methane reformer step, engineers were challenged by the furnace temperature distribution, limiting the application of a rigorous first-principles simulation. The Japanese company decided to apply the hybrid model approach by combining

first principles knowledge and machine learning from plant data, using a neural network to perform the calculations. The data was imported to Aspen Plus to create the neural network after selection of dependent and independent variables.

### First Principles-Driven Hybrid Model

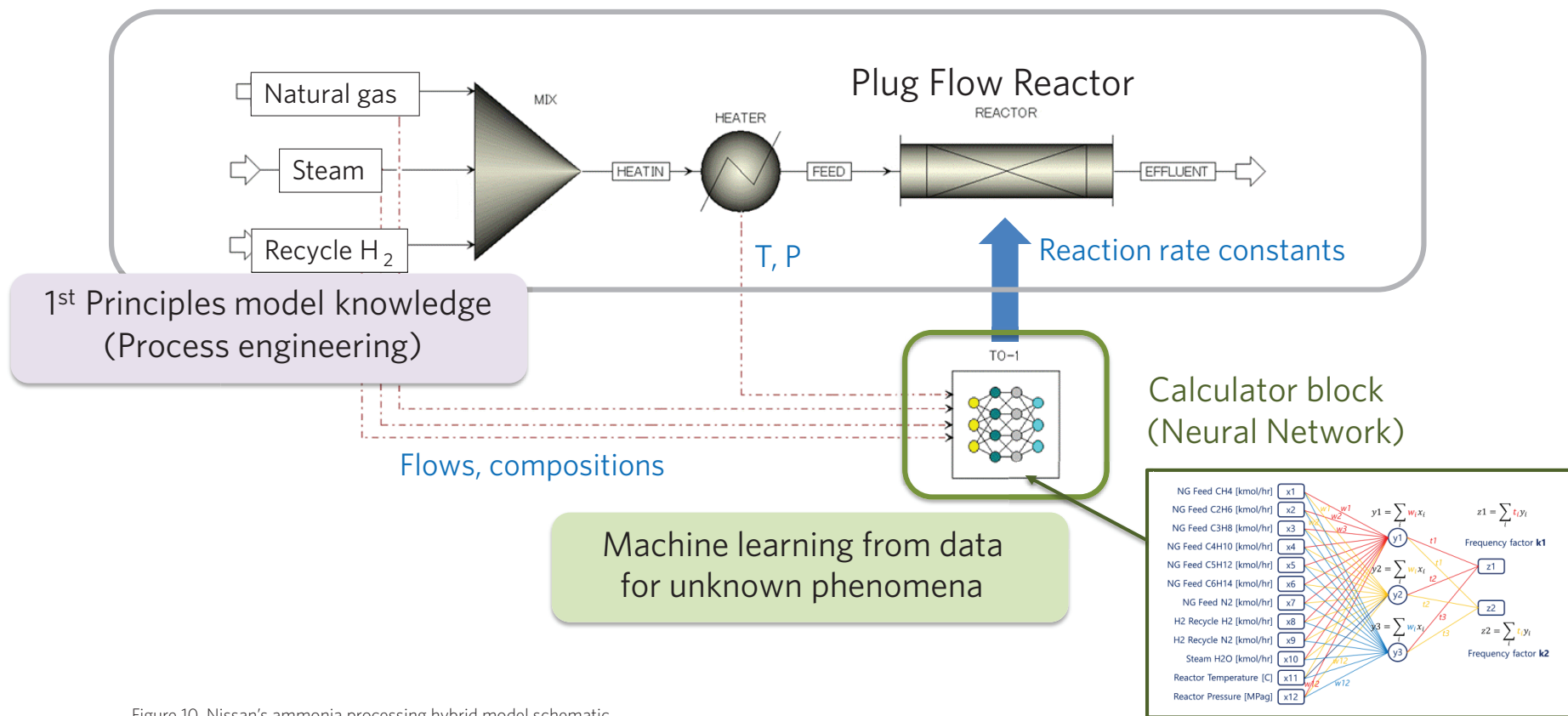

Figure 10. Nissan's ammonia processing hybrid model schematic.

Using the hybrid model, the Nissan team was able to fit the kinetic parameters and reproduce real plant data more accurately than the conventional reformer model. This offline digital twin is a highly accurate model was created in half the time of the conventional model.<sup>1</sup>

The model accuracy optimized the steam input and reduced the steam consumption by one percent.

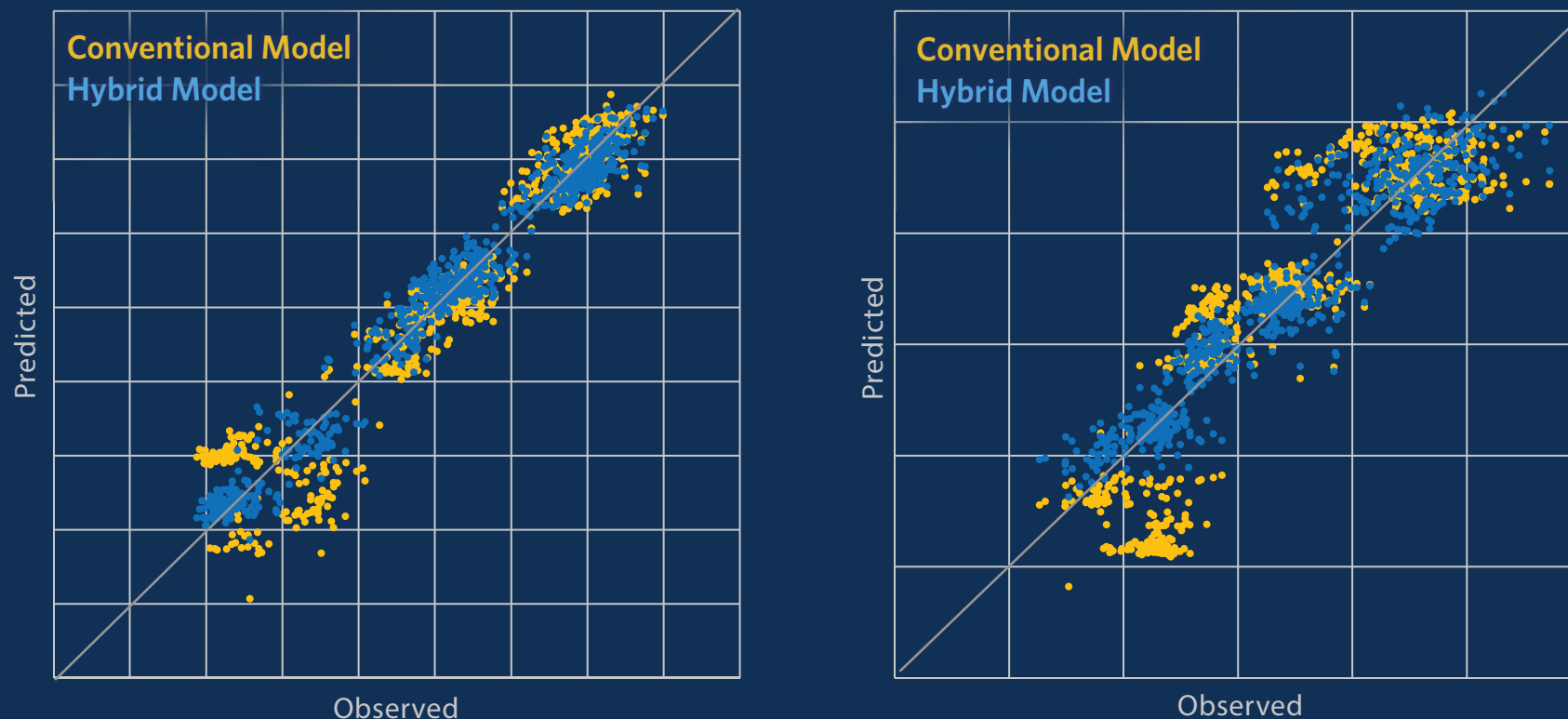

Figure 11. Conventional models vs hybrid models.

“Using the [AspenTech] hybrid model, we were able to create a model that can reproduce real plant data more accurately than the conventional reformer model. We were able to create a highly accurate model in a short period of time.”

—Mr. Takuto Nakai, Production Department, Nissan Chemical Corp.





## Conclusion

Global efforts to deliver products through processes that have less impact on the environment are driving a strategic shift in business metrics and practices. Digital twins are an important tool in this process, enabling improved process design, greater manufacturing insight, and better operational integrity. Many forward-looking companies have already begun this process, investing to build new capabilities, and developing innovative technologies and business models to achieve new targets.

The integration of sustainability targets with business goals will be transformational for chemical companies, especially as these topics are being raised in shareholder meetings, by large institutional investors and by external stakeholders. Furthermore, the target-oriented approach also positions businesses toward renewed growth and long-term business success. The Ellen MacArthur Foundation highlights that products developed for the circular economy offer as much as \$1 trillion in new business opportunity for companies that meet these objectives.<sup>4</sup>

Achieving the fragile balance of sustainability goals—equally considering people, planet, and profit—is a considerable challenge for organizations, but one that must be addressed to be competitive in the energy and chemical markets of today and tomorrow. Digital technologies and Industrial AI are critical capabilities that will separate market leaders from niche players of the future.

### Citations

<sup>1</sup> Originally presented by the customer as part of OPTIMIZE '21 conference, held in May 2021. Contact your AspenTech representative for more details.

<sup>2</sup> [www.aspentech.com/en/resources/white-papers/digital-emission-and-efficiency-monitoring-through-modeling-improves-sustainability-at-bpcl](https://www.aspentech.com/en/resources/white-papers/digital-emission-and-efficiency-monitoring-through-modeling-improves-sustainability-at-bpcl)

<sup>3</sup> Report, Digital Cafe Workshop, EPCA 53rd Annual Meeting, Berlin, October 2019, 'Digitalisation as an enabler for a sustainable future'

<sup>4</sup> *The Circular Design Guide*, The Ellen MacArthur Foundation





### **About AspenTechnology**

Aspen Technology (AspenTech) is a global leader in asset optimization software.

Its solutions address complex, industrial environments where it is critical to optimize the asset design, operation and maintenance lifecycle. AspenTech uniquely combines decades of process modeling expertise with artificial intelligence. Its purpose-built software platform automates knowledge work and builds sustainable competitive advantage by delivering high returns over the entire asset lifecycle. As a result, companies in capital-intensive industries can maximize uptime and push the limits of performance, running their assets safer, greener, longer and faster.

[aspentech.com](https://www.aspentech.com)

© 2021 Aspen Technology, Inc. All rights reserved. AT-07361

